

# KOMATSU

# HD785-7

OFF-HIGHWAY TRUCK



HD785

**ENGINE POWER**

895 kW / 1.200 HP @ 1.900 rpm

**NOMINAL PAYLOAD**

91 metric tons

**BODY CAPACITY, HEAPED**

60 m<sup>3</sup>

# Walk-Around



HD785-7

## ENGINE POWER

895 kW / 1.200 HP @ 1.900 rpm

## NOMINAL PAYLOAD

91 metric tons

## BODY CAPACITY, HEAPED

60 m<sup>3</sup>





## PRODUCTIVITY ON DEMAND

### *Powerful and Environmentally Friendly*

- Fuel efficient high performance Komatsu SAA12V140E-3 engine
- Variable horsepower control (VHPC) with mode selection system
- Komatsu fuel-saving technology
- Anti-pitching 4-wheel oil-cooled multiple disc retarder

### *First-Class Comfort*

- Wide, spacious cab with excellent visibility
- Air suspension seat
- Viscous cab mounts
- Three-mode hydropneumatic suspension (auto-suspension) (option)

### *Maximised Efficiency*

- Auto Retard Speed Control (ARSC)
- K-ATOMiCS transmission with “Skip-Shift” function
- Small turning radius
- Payload meter (PLM)

### *Safety First*

- Komatsu SpaceCab™ – Built-in ROPS/FOPS
- Integrated stairways with handrails and gentle slope

### *Reliability & Maintenance*

- High strength body
- Hydraulically controlled wet multiple-disc brakes and retarder
- Centralized greasing points
- Centralized arrangement of filters

### *KOMTRAX Plus*

- Komatsu Wireless Monitoring System
- Increased operational data and fuel savings

# Powerful and Environmentally Friendly



## High performance Komatsu SAA12V140E-3 engine

This engine delivers faster acceleration and higher travel speeds with high horsepower per ton. Advanced technology, such as High Pressure Common Rail injection system (HPCR), air-to-air aftercooler efficient turbo-charger gives high torque at low speed, impressive acceleration, and low fuel consumption for maximum productivity.

## Komatsu fuel-saving technology

Hydraulic circuits such as brake cooling, steering, body dump control, transmission control etc. are optimized to reduce fuel consumption. As a result, the fuel consumption for operation with medium and light load is improved.

## Anti-pitching 4-wheel oil-cooled multiple disc retarder

With this retarder, the retarding force is shared between four wheels. This reduces the possibility of tire-lock and enables effective use of retarder capacity, allowing stable downhill travel. The machine descends slopes smoothly and comfortably without machine pitching since retarding force on front and rear wheels is controlled independently.

HD785-7



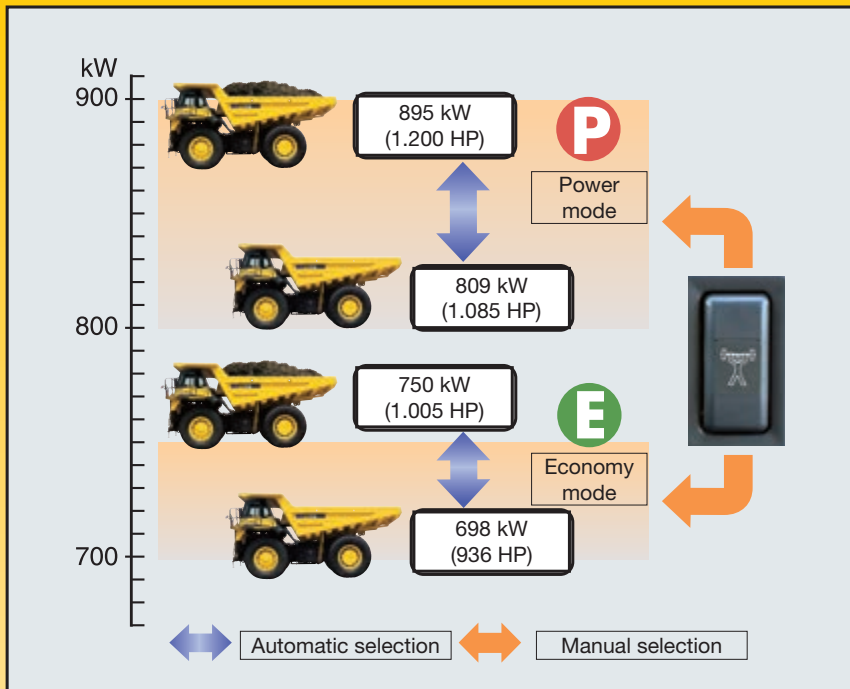
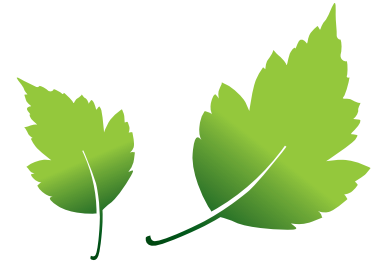

**Variable horsepower control (VHPC) with mode selection system**

The variable displacement piston pumps reduce loss of Power Take-Off (PTO). Improvements in hydraulic pressure for transmission control increase energy savings, and the sophisticated electronic control of the engine operation helps to achieve optimal energy efficiency.

Both in Power and Economy modes, the VHPC system detects whether machine condition is loaded or unloaded and selects optimum horsepower setting mode, providing both high production and low fuel consumption.

**Power mode:** Makes best use of the horsepower to attain optimal production. This mode is suitable for operation in job sites including uphill travel with load where powerful hauling is top priority.

**Economy mode:** Sets the maximum horsepower at low level to reduce fuel consumption. The machine maintains sufficient power for economical operation in this mode.

**Automatic Idling Setting System (AISS)**

This system facilitates quick engine warm-up and cab cooling/warming. When setting the system ON, engine idle speed is kept at 945 rpm when coolant temperature is 50 °C or lower. Speed automatically returns to 750 rpm when coolant temperature reaches 50°C.

**Brake cooling oil recovery tank**

A tank is installed on each rear wheel to capture brake cooling oil in the event of leakage from the floating seal.

**Lead-free radiator**

In addition to compliance with emission regulations, a leadfree aluminum core is used for the radiator to meet global environmental requirements

**Large body**

A wide target area makes for easy loading with minimal soil spillage and more efficient hauling. Heaped capacity: 60,0 m³  
Target area (inside length x width): 7.065 mm x 5.200 mm

**Long wheelbase and wide tread**

With an extra-long wheelbase, a wide tread and an exceptionally low center of gravity, the HD785-7 hauls the load at higher speed for greater productivity, and delivers superior driving comfort over rough terrain.



# Maximised Efficiency



## Payload meter (PLM)

The payload is indicated on the Equipment Management Monitor. This option allows the production volume and the working conditions on the dump trucks to be analyzed directly via a personal computer. The system can store up to 2.900 working cycles.



## Komatsu Traction Control System (KTCS) (optional)

KTCS continuously monitors the rear wheels' rotating speed and vehicle speed for slippage. In case of excessive wheel slip, the brake is automatically applied, and optimum tire traction is maintained. KTCS activates and deactivates automatically, and improves productivity and tire life more than the conventional ASR system.



## K-ATOMiCS transmission

K-ATOMiCS is an electronic shift control with automatic clutch modulation in all gears. It optimizes oil pressure for the clutch engagement and provides smoother shifting without torque off.



## Auto Retard Speed Control (ARSC)

ARSC allows to easily set a constant downhill travel speed and lets the operator concentrate on steering. Speed can be adjusted appropriately to the slope grade at an increment of 1 km/h by clicking the control lever ( $\pm 5$  km/h max.).

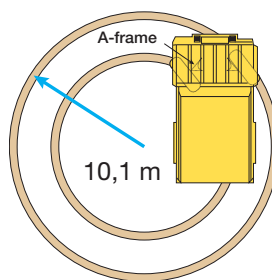

## Small turning radius

The MacPherson strut type front suspension has a special A-frame between each wheel and the main frame. The wider space created between the front wheels and the main frame increases the turning angle of the wheels. The larger this turning angle, the smaller the turning radius of the truck.

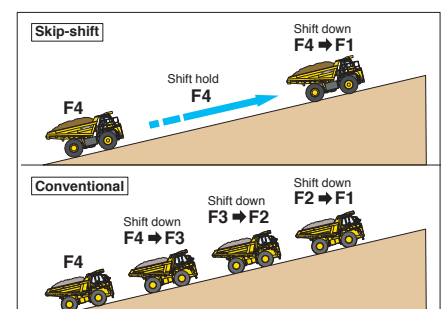

## Skip shift function

Automatically selects a gear position depending on the slope grade when driving uphill, without shifting down through each gear. It reduces the number of downshifts, makes driving smoother, improves operator's comfort and reduces material spillage.







# First-Class Comfort



## Wide and comfortable cab

The wide Komatsu SpaceCab™ with user-friendly controls provides a comfortable and safe work environment. A fully adjustable air-suspended seat dampens vibrations and reduces the fatigue of long shifts. Large front and electric side windows give a superior visibility and increased confidence. The rear window can be electrically heated for quick defrosting.

## MacPherson strut type front suspension

The MacPherson type independent suspension is installed to the front wheels. The linkage arrangement with less friction allows the front wheel to follow the undulation of road surface smoothly, realizing excellent riding comfort.

## Low-noise design

To reduce noise levels, the cab is mounted on viscous dampeners. Further noise reduction is achieved by the integrated cab floor: it makes the cab air-tight and seals off the engine compartment. A low-noise and sound-insulated muffler helps to bring sound levels way down.



*Electric body dump control lever*  
The low effort lever makes dumping easier than ever. A positioning sensor is installed for dump body control which significantly reduces the shock made by the lowering of the dump body.



*The instrument panel makes it easy to monitor critical machine functions. In addition, a caution light warns the operator of any problems that may occur.*



*Three-mode hydropneumatic suspension (Auto-suspension) (Option)*  
For a comfortable and stable ride, the suspension mode is automatically switched to one of three stages (soft, medium and hard) according to load and operating conditions.



# Tough and Reliable

## Loading policy

Each dump truck has its own “target payload”. Respecting the “Loading Policy” maximizes productivity with the full utilization of the vehicle performance. It reduces operating costs, and extends the life of brakes, tires, and other components.

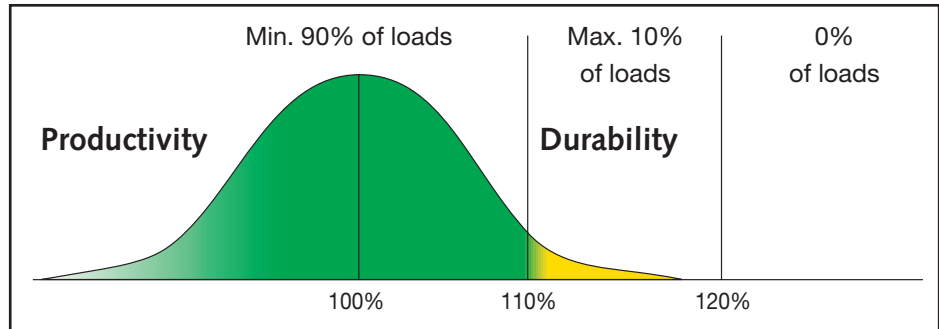

## 10/10/20 policy

- Monthly average payload must not exceed the truck’s target payload.
- No less than 90% of all loads must be up to 110% of the truck’s target payload.
- No more than 10% of all loads may be between 110% and 120% of the truck’s target payload.
- Any single load must not exceed 120% of the truck’s target payload.



## High-rigidity frames

Front support is integrated with the frame. The frame rigidity is increased drastically. As a result, flexural rigidity and torsional rigidity that are indicators of drivability and riding quality are significantly improved.



## Rugged and durable dump body design

Several different types of bodies are selectable, with optional equipment for various load conditions prepared for each one.

The standard dump body is made of high-tensile-strength steel with a Brinell hardness of 400 for excellent rigidity and reduced maintenance cost.

The V-shape and V-bottom design also increase structural strength. The side and bottom plates of the dump section are reinforced with ribs for added strength.



# Safety First



ROPS/FOPS to ISO 3471 ROPS and ISO 3449 FOPS Level II standard



Excellent all-round visibility



Safe cab access The low angle of the front stairways with handrails, slip-resistant



## Pedal-operated secondary brake

If there should be a failure on the foot brake circuit, both front and rear parking brakes are activated as a pedal operated secondary brake. In addition, when hydraulic pressure drops below the rated level, the parking brake is automatically actuated.

## Supplementary steering and secondary brakes

Standard features on the HD785-7 include supplementary steering and secondary brakes. They help to guarantee safety in emergency situations.

## Antilock brake system (ABS) (optional)

This system prevents the tires from locking when using the service brake and the retarder, thus minimizing skidding under slippery conditions.

## Speed limiter

Maximum travel speed is limited independently for both empty and loaded conditions. The optional overload speed limiter limits the maximum travel speed to 15 km/h when the payload exceeds the threshold value.

## Secondary engine shutdown switch

Located in the cab for emergency use.





# Easy Maintenance



### Long service intervals

Engine oil at 500 hours and hydraulic oil at 4.000 hours change intervals minimize operating cost.



### Centralized greasing points

Greasing points are located accessible from ground level to make daily maintenance easier.



### Centralized arrangement of filters

The filters are centralized so that they can be serviced easily.

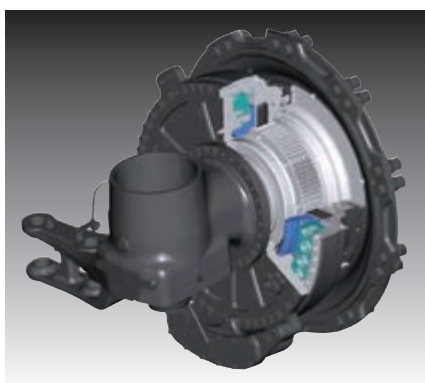

### Wet multiple-disc brakes and fully hydraulic braking system

The multi-disc service brake is encapsulated and runs in an oil bath. The brake stays clean and operates at low temperature for increased service intervals and a long lifetime.



### Electric circuit breaker

A circuit breaker is adopted in important electric circuits that should be restored in a short time when a problem occurs in the electrical system.



### Equipment Management Monitoring System (EMMS)

The electronic display panel shows current vehicle condition and how to fix them with action codes and check results with service codes.

# KOMTRAX

## What

- KOMTRAX is Komatsu's remote equipment monitoring and management system
- KOMTRAX is standard equipment on all Komatsu construction products
- KOMTRAX continuously monitors and records machine health and operational data
- Information such as fuel consumption, utilization, and a detailed history aids in making repair or replacement decisions

## When

- Know when your machines are running or idling and make decisions that will improve your fleet utilization
- Detailed movement records ensure you know when and where your equipment is moved
- Up to date records allow you to know when maintenance was done and help you plan for future maintenance needs

## Where

- KOMTRAX data can be accessed virtually anywhere through your computer, the web or your smart phone
- Automatic alerts keep fleet managers up to date on the latest machine notifications

## Why

- Knowledge is power - make informed decisions to manage your fleet better
- Knowing your idle time and fuel consumption will help maximize your machine efficiency
- Take control of your equipment - any time, anywhere



## KOMTRAX Plus

### Equipment management support

KOMTRAX Plus enables expanded monitoring of the fleet via satellite. Users can analyze "machine health" and performance from a remote location. This includes component condition and trend data. By making this critical information readily accessible, KOMTRAX Plus is an effective tool in maximizing productivity and lowering operating cost.



# Specifications

## ENGINE

Model	Komatsu SAA12V140E-3
Type	Common rail direct injection, water-cooled, turbocharged, after-cooled diesel
Engine power	
at rated engine speed	1.900 rpm
ISO 14396	895 kW/1.200 HP
ISO 9249 (net engine power)	879 kW/1.179 HP
No. of cylinders	12
Bore x stroke	140 x 165 mm
Displacement	30,48 l
Max. torque	518 kgf-m
Governor	Electronically controlled
Lubrication system	
Lubrication method	Gear pump, force lubrication
Filter	Full-flow filter
Air-filter type	Dry type with double elements, precleaner and evacuator valve

## TRANSMISSION

Torque converter	3-element, 1-stage, 2-phase
Transmission	Full-automatic, planetary type
Speed range	7 speeds forward and 2 reverse (RH/RL)
Lock-up clutch	Wet, multiple-disc clutch
Forward	Torque converter drive in 1st gear, direct drive in 1st lock-up and all higher gears
Reverse	Torque converter drive (lockup)
Shift control	Electronic shift control with automatic clutch modulation in all gears
Max. travel speed	65 km/h

## STEERING SYSTEM

Type	Full-hydraulic power steering with two double-acting cylinders
Supplementary steering	Automatically and manually controlled (meets ISO 5010 and SAE J1511)
Minimum turning radius, centre of front tyre	10,1 m
Max. steering angle (outside tyre)	41°

## SUSPENSION

Independent, hydropneumatic suspension cylinder with fixed throttle to dampen vibration.	
Effective cylinder stroke:	
Front suspension	320 mm
Rear suspension	127 mm
Rear axle oscillation	6,5°

## AXLES

Final drive type	Planetary gear
Rear axle	Full-floating
Ratios:	
Differential	3,357
Planetary	6,333

## BRAKES

Brakes meet ISO 3450 standard.	
Service brakes:	
Front	Full-hydraulic control, oil-cooled multiple-disc type
Rear	Full-hydraulic control, oil-cooled multiple-disc type
Parking brake	Spring applied, multiple-disc type, acting on all wheels
Retarder	Oil-cooled, multiple-disc rear brakes act as retarder
Retarder capacity (continuous)	1.092 kW / 1.464 HP
Secondary brake	Manual pedal operation. When hydraulic pressure drops below the specified level, parking brake is automatically actuated.
Brake surface:	
Front	37.467 cm <sup>2</sup>
Rear	72.414 cm <sup>2</sup>

## MAIN FRAME

Type	Box-sectioned structure. Integral front bumpers
------	---

## SERVICE REFILL CAPACITIES

Fuel tank	1.308 l
Engine oil	129 l
Torque converter, transmission and retarder cooling	205 l
Differentials (total)	137 l
Final drives (total)	128 l
Hydraulic system	175 l
Brake control	36 l
Suspension (total)	93 l

## HYDRAULIC SYSTEM

Hoist cylinder	Twin, 2-stage telescopic type
Relief pressure	20,6 MPa (210 kg/cm <sup>2</sup> )
Hoist time (at high idle)	14 s

# Specifications

## TYRES

Standard tyres	27.00 R49
----------------	-----------

## CAB

Complies with ISO 3471 ROPS (Roll-Over Protective Structure) and ISO 3449 level II FOPS (Falling Object Protection Structure) standards.

## WEIGHT (APPROX.)

Empty weight	72.600 kg
Gross vehicle weight	163.680 kg
Weight distribution	
Empty:	
Front axle	47%
Rear axle	53%
Loaded:	
Front axle	31,5%
Rear axle	68,5%

## ENVIRONMENT

Engine emissions	Exempt from EU exhaust emission regulations
Noise level, LpA operator ear	75 dB(A) (ISO 6396 dynamic test)
Vibration levels (EN 12096:1997)	
Hand/arm	$\leq 2,5 \text{ m/s}^2$ (uncertainty $K = 0,65 \text{ m/s}^2$ )
Body	$\leq 0,5 \text{ m/s}^2$ (uncertainty $K = 0,21 \text{ m/s}^2$ )
Contains fluorinated greenhouse gas HFC-134a (GWP 1430). Quantity of gas 0,9 kg, CO <sub>2</sub> equivalent 1,29 t	

## BODY

Capacity:	
Struck	40 m <sup>3</sup>
Heaped (2:1, SAE)	60 m <sup>3</sup>
Payload	91 metric tons
Material	130 kg/mm <sup>2</sup> high tensile strength steel
Material thickness:	
Bottom	19 mm
Front	12 mm
Sides	9 mm
Target area (inside length x width)	7.065 mm x 5.200 mm
Heating	Exhaust heating

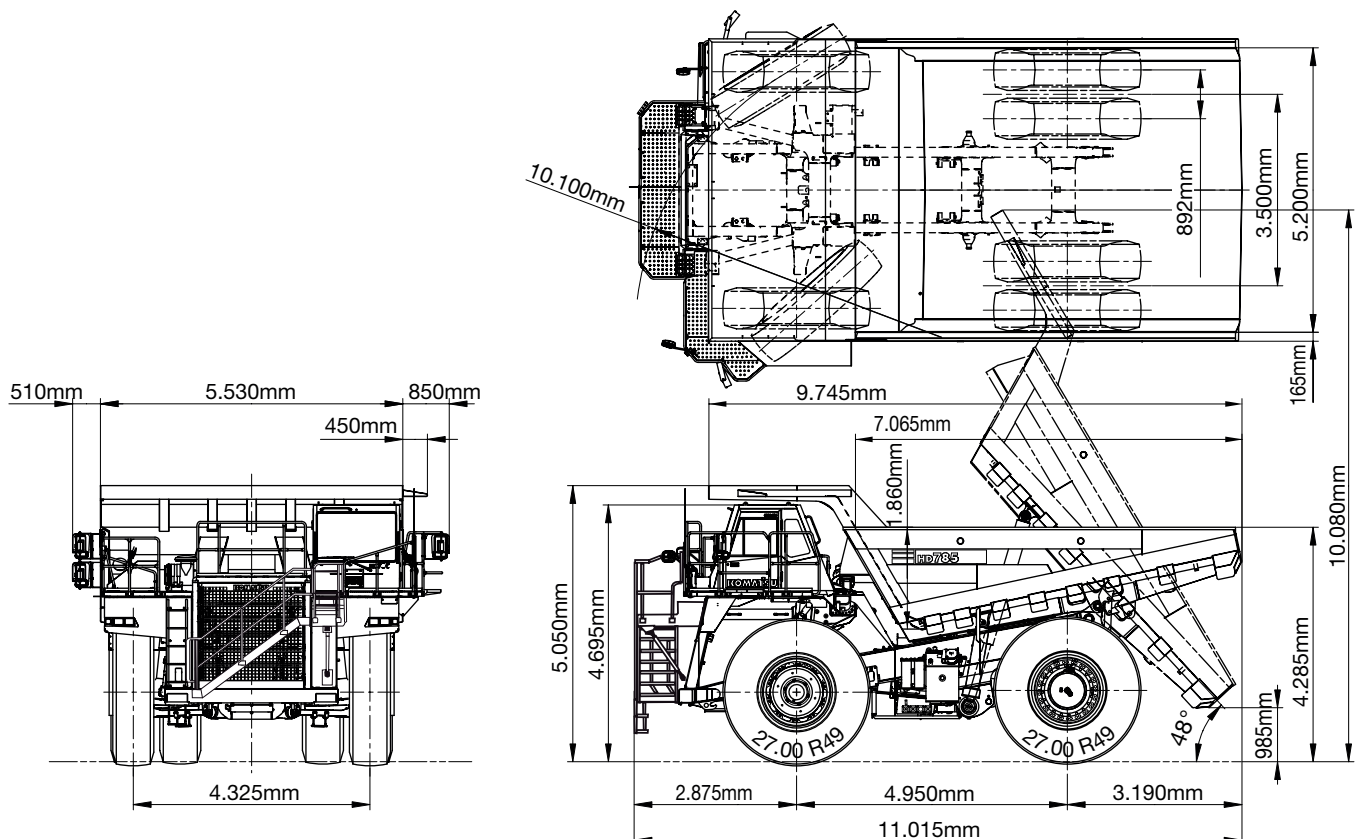



### TRAVEL PERFORMANCE

To determine travel performance: Read from gross weight down to the percent of total resistance. From this weight-resistance point, read horizontally to the curve with the highest obtainable speed range, then down to maximum speed. Usable rimpull depends upon traction available and weight on drive wheels.

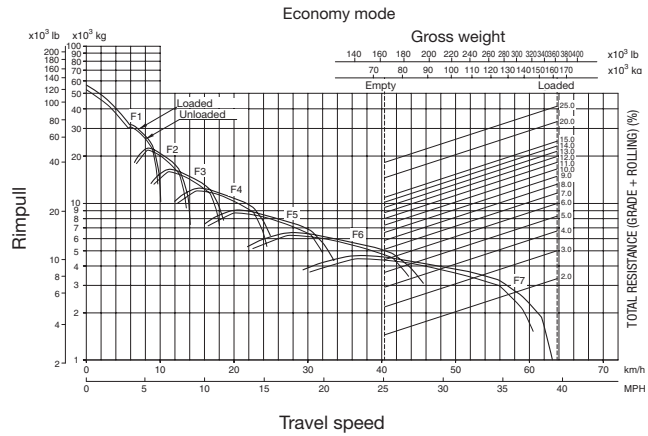
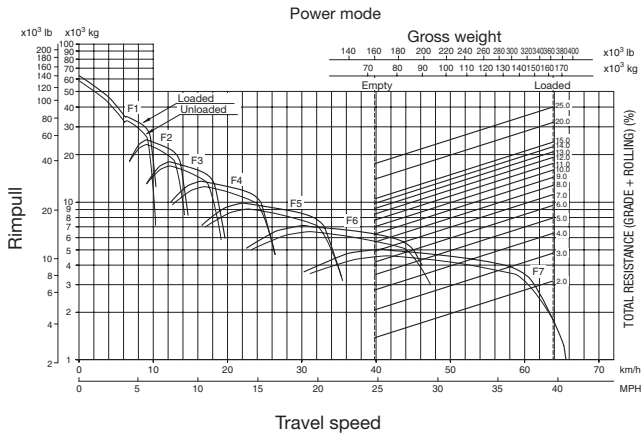

### BRAKE PERFORMANCE

To determine brake performance: These curves are provided to establish the maximum speed and gearshift position for safer descents on roads with a given distance. Read from gross weight down to the percent of total resistance. From this weight resistance point, read horizontally to the curve with the highest obtainable speed range, then down to maximum descent speed the brakes can safely handle without exceeding cooling capacity.

GRADE DISTANCE: CONTINUOUS DESCENT

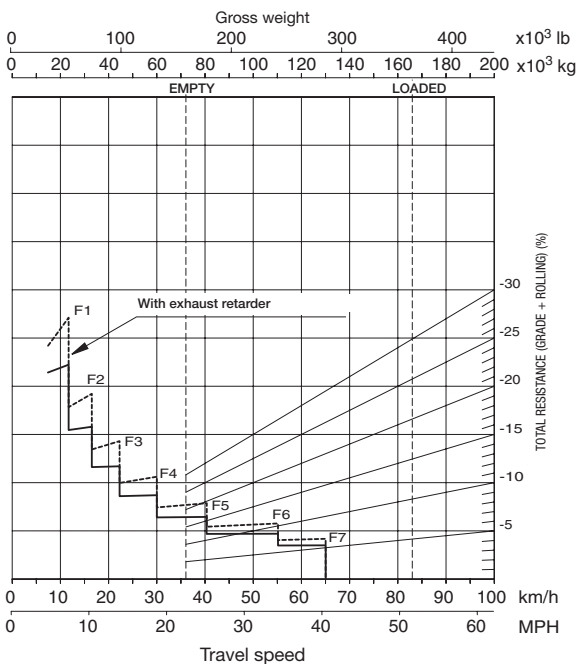

GRADE DISTANCE: 450 M

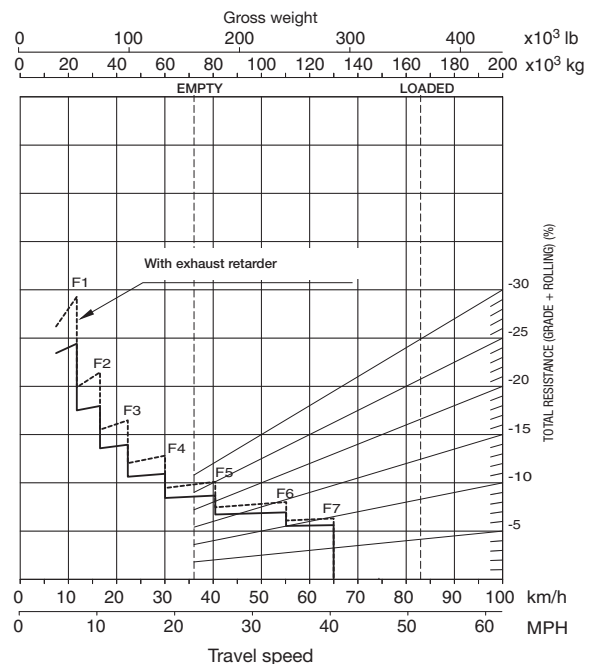

# Standard and Optional Equipment

## ENGINE

Komatsu SAA12V140E-3 turbocharged common rail direct injection diesel engine	●
AISS (Automatic Idling Setting System)	●
Engine power mode selection system with VHPC	●
Alternator 90 A/24 V	●
Starter motor 2 × 7,5 kW	●
Batteries 4 × 12 V/136 Ah	●
Dry type air cleaner, double element with dust indicator	●
Engine oil & coolant heater	○
High-capacity batteries	○
Starter motor 2 x 11 kW	○
Engine prelubrication	○

## BODY

Body exhaust heating kit	●
Spill guard, 300 mm	●
Electronic hoist control system	●
Cab guard (l.h.)	●
Platform guard (r.h.)	●
Body liners	○
Muffler without body heating	○
Muffler with body heating	○

## OTHER EQUIPMENT

Exhaust thermal guard	●
Fire prevention covers	●
Engine underguard	●
TM underguard	●
Drive shaft guard (front and rear)	●
Engine side covers	●
Lockable fuel cap and covers	●
Cold area arrangement (-30 °C to 40 °C)	○
Radiator shutter, canvas type	○

## CABIN

ROPS/FOPS cab, sound suppression type with tinted windows, front laminated glass, two doors (left and right)	●
Operator seat, reclining, air suspension type with retractable 3-point seat belt	●
Trainer seat with 2-point seat belt	●
Steering wheel, tilt and telescopic	●
Cigarette lighter, ashtray, cup holder, space for lunch box	●
Air conditioner	●
Sun visor	●
Sun visor, additional	●
Windshield washer and wiper (with intermittent feature)	●
Power window (l.h.)	●
Pre radio installation	●
AM/FM radio	●
Power window (r.h.)	●

## SERVICE AND MAINTENANCE

Centralized greasing	●
Electric circuit breaker, 24 V	●
PM service connections	●
Poor fuel arrangement (water and dust)	●
Fuel tank with fast fill coupler	●
KOMTRAX Plus – Komatsu wireless monitoring system	●
Payload meter function on KOMTRAX Plus	●
Engine room lamp	●
Automatic greasing system	○
Fast oil fill system	○

## AXLES AND TYRES

MacPherson strut type front suspension	●
Tyres 27.00-R49	●
Automatic suspension, 3-mode	○
Tyres 31/90 R49	○
Adjustable tie rod	○

## SAFETY EQUIPMENT

Anti-pitching 4-wheel oil-cooled multiple-disc retarder (AP-FOUR)	●
Back-up alarm	●
Horn, electric	●
Coolant temperature alarm and light	●
Hand rails for platform	●
Ladders, left and right hand side	●
Supplementary steering, automatic	●
Overrun warning system	●
ARSC (Auto Retard Speed Control)	●
Rearview mirrors	●
Underview mirrors	●
Rear view camera and monitor	●
Front stairway with handrails	●
Overload and maximum speed limiter	●
ABS (Anti-lock Braking System)	○
Exhaust retarder	○
Komatsu Traction Control System	○

## LIGHTING SYSTEM

Back-up light	●
Hazard lights	●
Headlights with dimmer switch	●
Indicator, stop and tail lights	●
Fog lights	●
LED combination lights, rear	●
Back-up light, additional	○
Rear working lights, left and right	○

Further equipment on request

- standard equipment
- optional equipment

Your Komatsu partner:

# KOMATSU

**Komatsu Europe  
International N.V.**

Mechelsesteenweg 586  
B-1800 VILVOORDE (BELGIUM)  
Tel. +32-2-255 24 11  
Fax +32-2-252 19 81  
[www.komatsu.eu](http://www.komatsu.eu)

EENSS20341 12/2018

**KOMATSU** is a trademark of Komatsu Ltd. Japan.